



**memmert**  
Experts in Thermostatics

## wiring diagram



CO2 incubator  
with active humidity  
and uninterruptible power supply

designation: ICO

size: 150

nominal voltage: 115V with UPS

drawing number: D39589

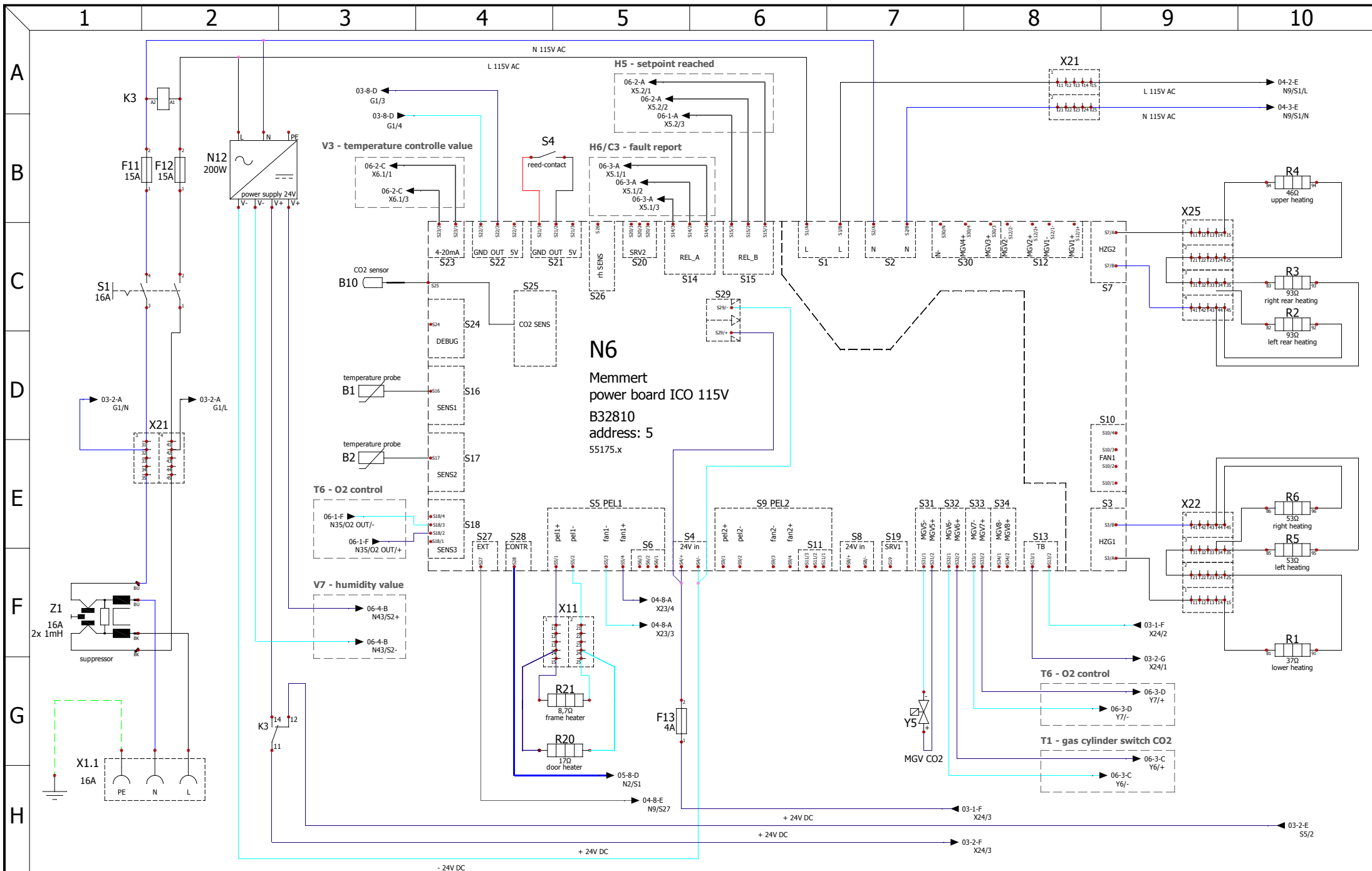

<b>power board</b>			designation: <b>ICO</b> with active humidity	unit or size: <b>150</b>	rev	modification	date	name	page
			drawing number: <b>D39589</b>	nominal voltage: <b>115V with UPS</b>	A	05.12.2018	Chr.Seyfarth	13	
created by Chr.Seyfarth	date 29.11.2018	name Chr.Seyfarth							
checked by M.Hammerbacher	date 05.12.2018	name M.Hammerbacher							



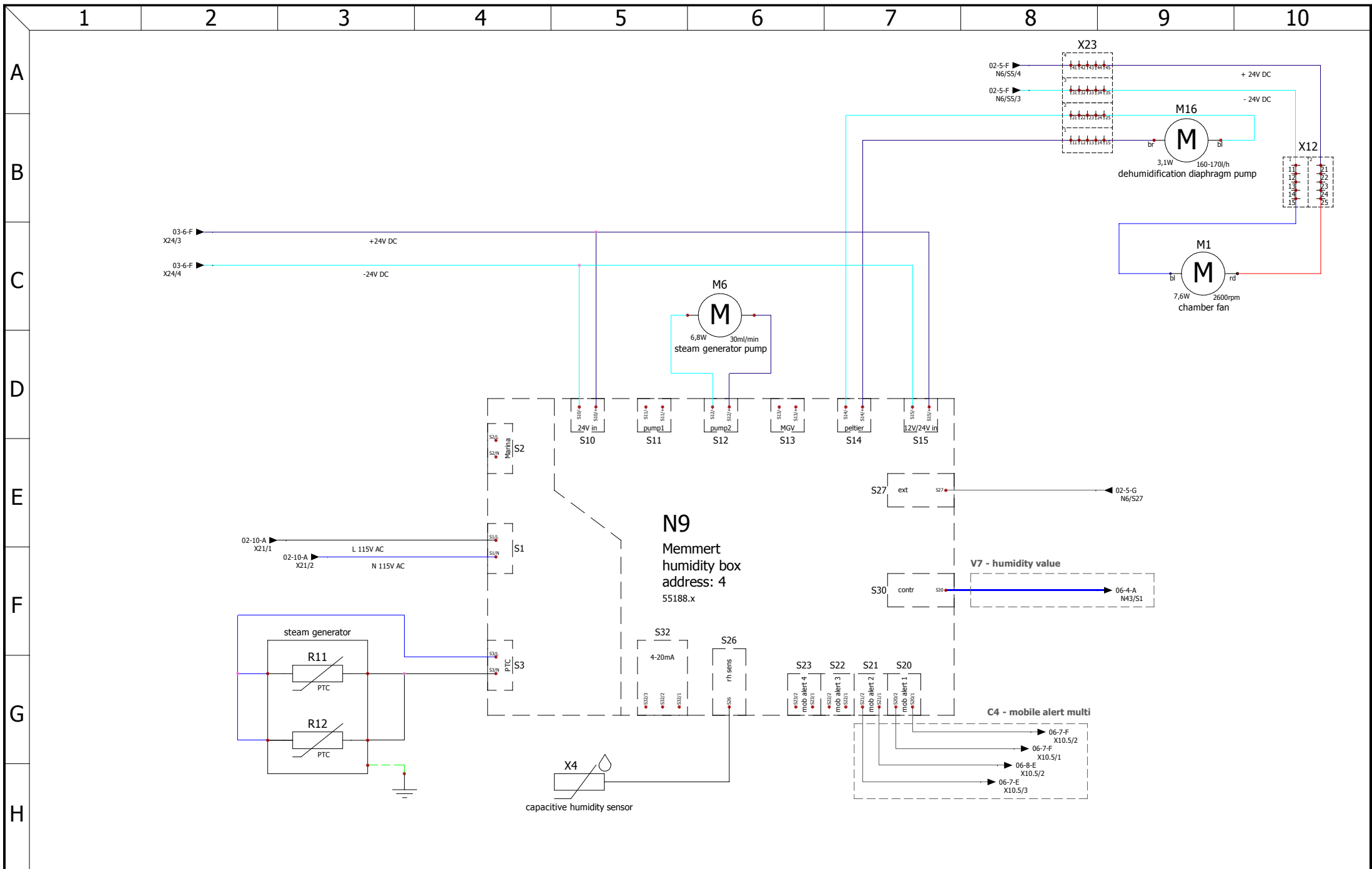

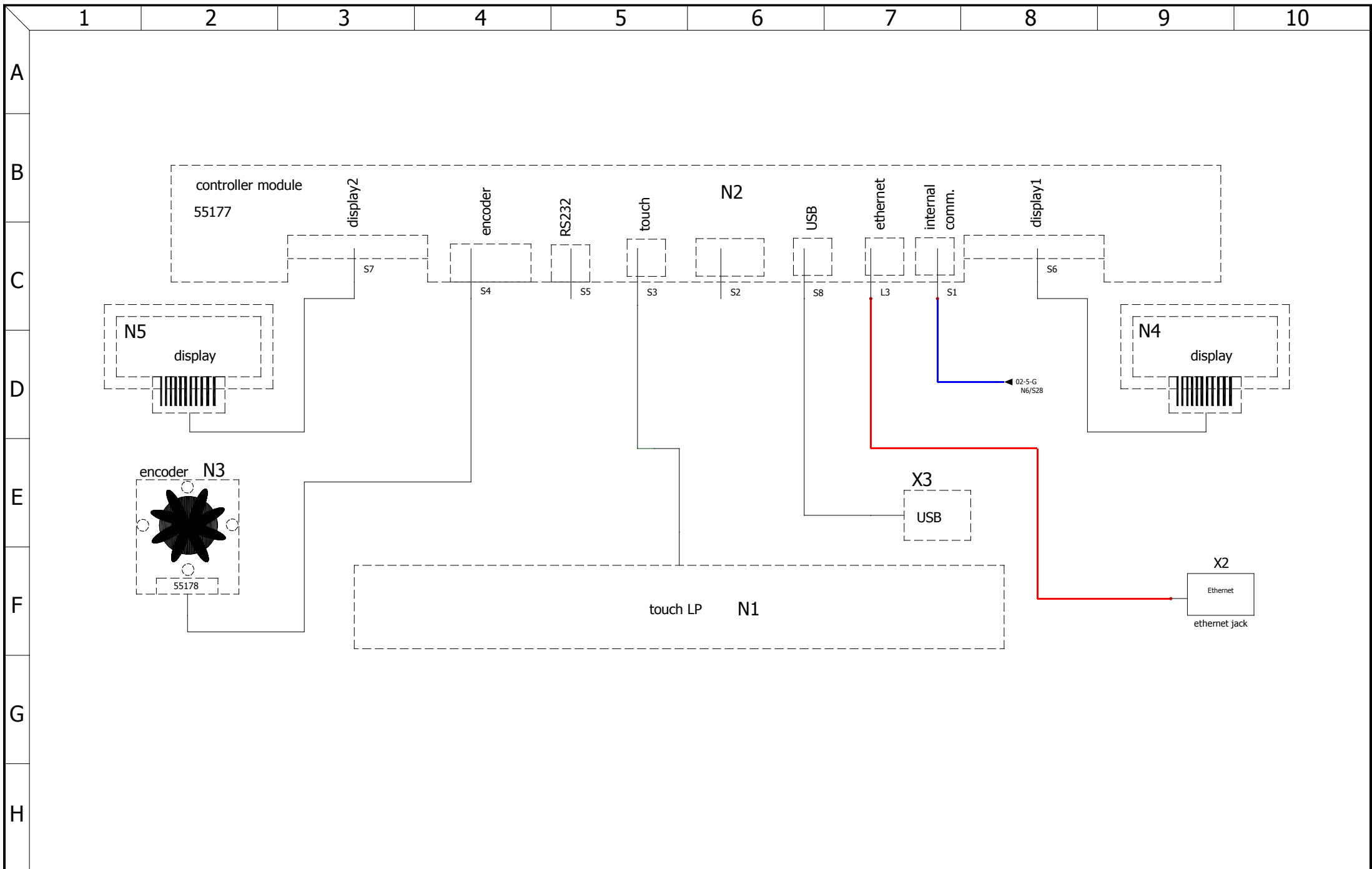

<b>controller unit</b>		
	date	name
created by	29.11.2018	Chr.Seyfarth
checked by	05.12.2018	M.Hammerbacher

designation:	ICO with active humidity
drawing number:	<b>D39589</b>

unit or size:	<b>150</b>
nominal voltage:	<b>115V with UPS</b>

rev	modification	date	name	page
				05
A		05.12.2018	Chr.Seyfarth	13

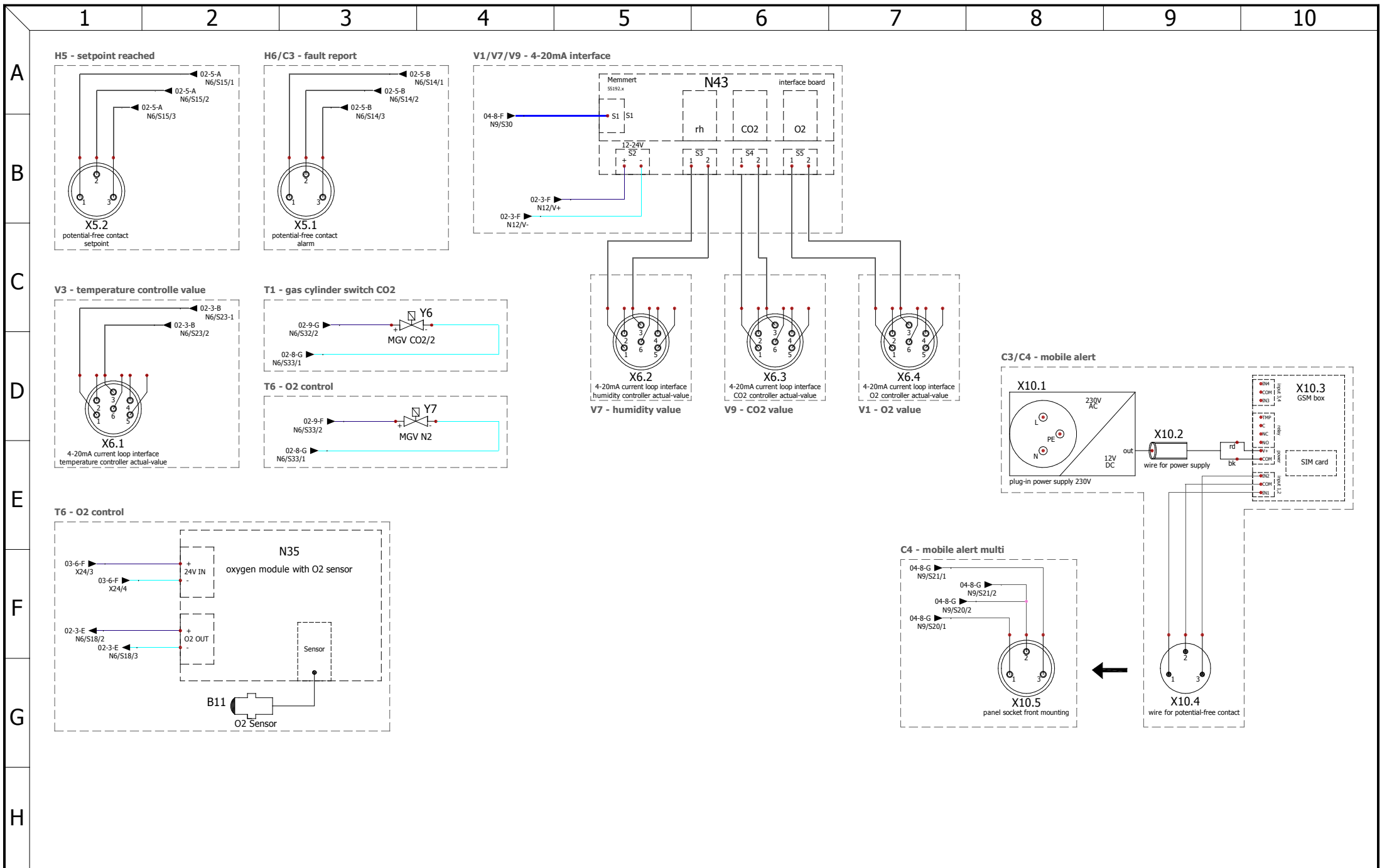

 Experts in Thermostatics	<b>options</b>		designation: <b>ICO</b> with active humidity	unit or size: <b>150</b>	rev	modification	date	name	page
		date	name	drawing number: <b>D39589</b>					
	created by	29.11.2018	Chr.Seyfarth		nominal voltage: <b>115V with UPS</b>				
	checked by	05.12.2018	M.Hammerbacher			A		05.12.2018	Chr.Seyfarth

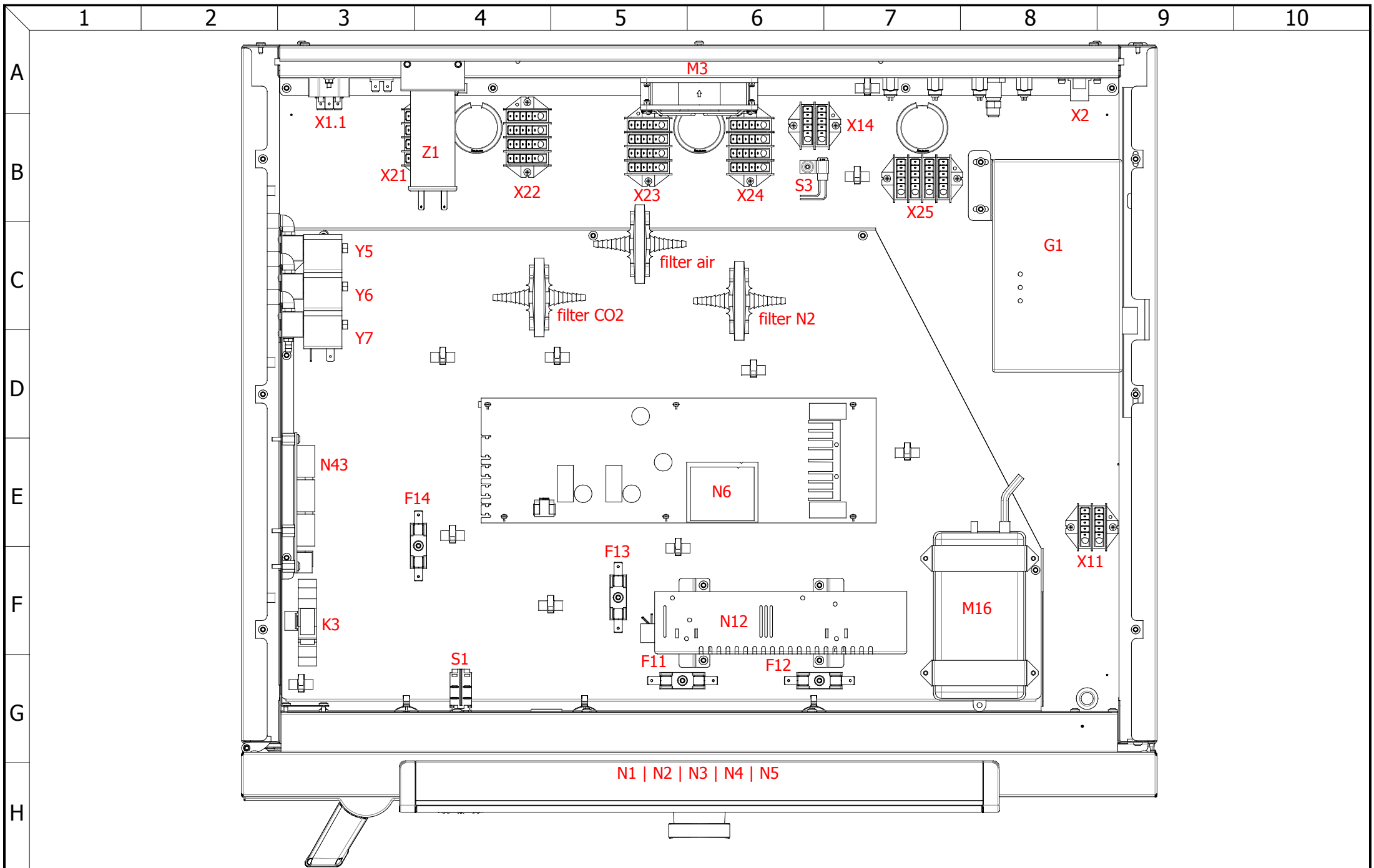

control enclosure		
	date	name
created by	29.11.2018	Chr.Seyfarth
checked by	05.12.2018	M.Hammerbacher

designation:	ICO
	with active humidity
drawing number:	D39589

unit or size:	150
nominal voltage:	115V with UPS

rev	modification
A	

date	name	page
		07
05.12.2018	Chr.Seyfarth	13

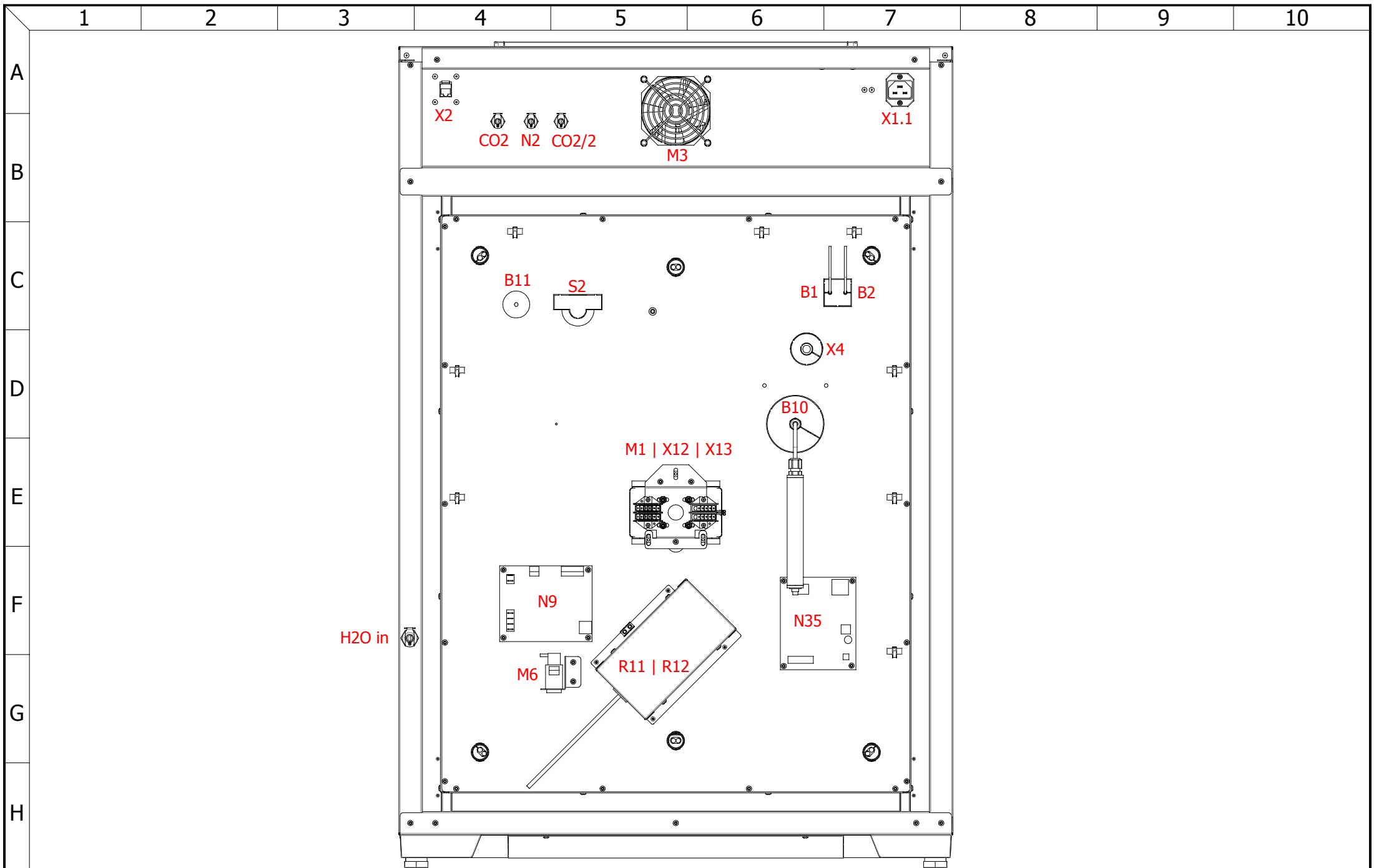

back		designation: <b>ICO</b> with active humidity		unit or size: <b>150</b>		rev	modification	date	name	page
		drawing number: <b>D39589</b>		nominal voltage: <b>115V with UPS</b>						<b>08</b>
created by	29.11.2018	Chr.Seyfarth								
checked by	05.12.2018	M.Hammerbacher			A		05.12.2018	Chr.Seyfarth	<b>13</b>	



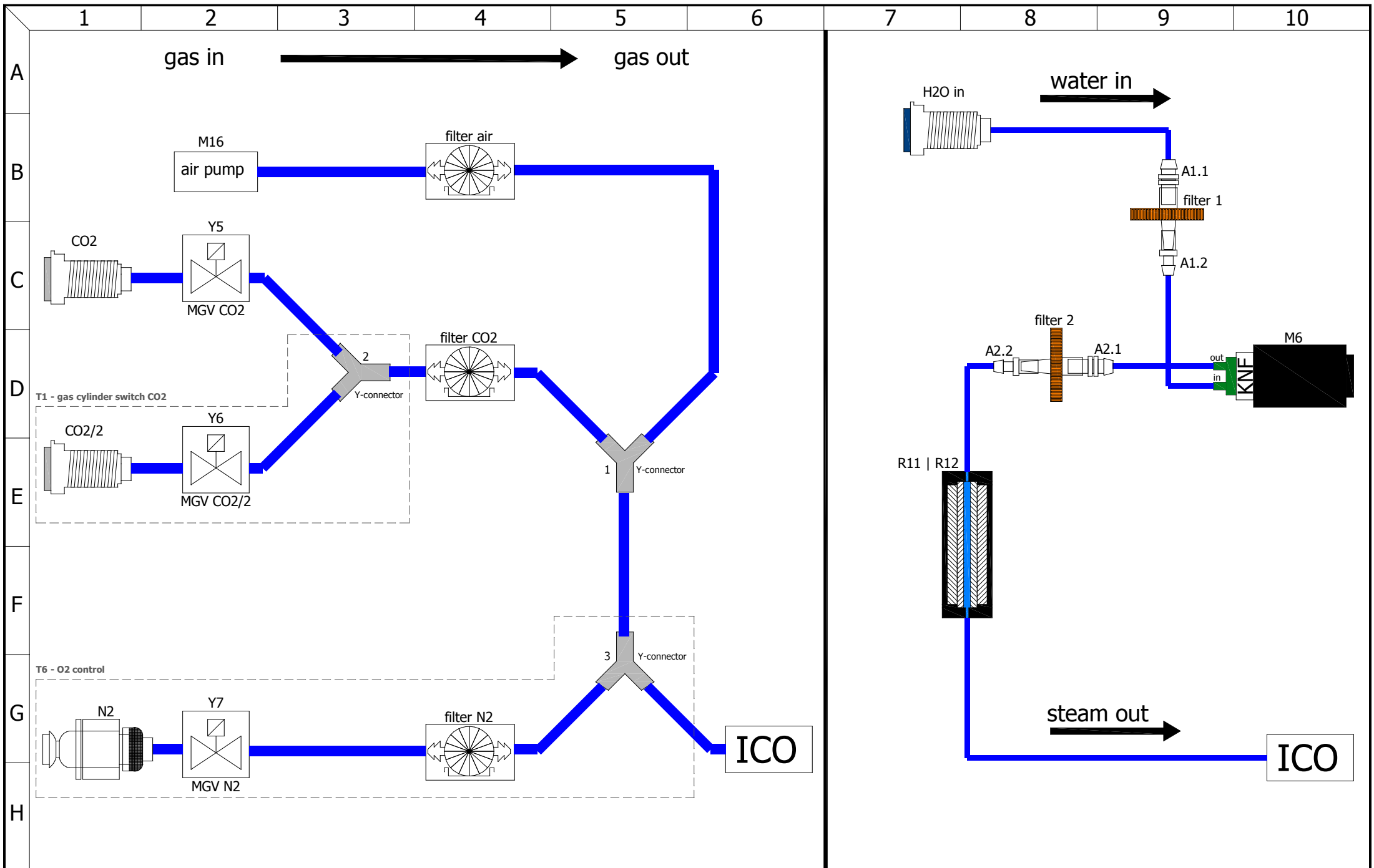

mark	article number	description	quantity
-	B33260	cable harness ICO 105 ah	1
B1   B2	E07285	temperature sensors	2
B10	B38220	CO2 sensor sterilizable	1
B10	E38244	connection cable CO2 sensor	1
F11   F12	E02387	fuse 15A	2
F13   F14	E07327	fuse 4A	2
G1	B39026	UPS uninterruptible power supply	1
K3	E04374	Solid State Relay Series 49, 230V/AC(50/60Hz); 2 NO/NC 250V/8A	1
M1   X12   X13	B38840	fan motor preassembled ICO 50/105/150/240	1
M3	E04796	DC brushless fan	1
M6	E07290	solenoid diaphragm pump	1
M16	E07336	air pump	1
N1   N2   N3   N4   N5	B30890	controller unit small plus twin display	1
N6	B32810	power board ICO 115V	1
N9	B38929	humidity power board	1
N12	B38079	switching power supply 24V/200W	1
R1	B33435	lower heating ICO/HCP 150	1
R2	B33436	left rear heating ICO/HCP 150	1
R3	B33437	right rear heating ICO/HCP 150	1
R4	B33438	upper heating ICO/HCP 150	1
R5	B33439	left heating ICO/HCP 150	1
R6	B33440	right heating ICO/HCP 150	1

mark	article number	description	quantity
R11   R12	B35344	steam generator ICO 50/105/150/240	1
R20	B40280	door heater ICO/HCP 150	1
R21	B38902	frame heater ICO 150	1
S1	E06137	power push-button-switch	1
S2	B39105	temperature limiter 230°C	1
S3	E07292	temperature switch $\geq 50^{\circ}\text{C}$	1
S4	B38952	reed-contact	1
S5	E07307	switch illuminated 1-pole	1
X2	E06251	ethernet jack	1
X4	B05249	capacitive humidity sensor	1
X11   X14	E07368	distribution block 2pol.	2
X21   X22   X23   X24   X25	E07369	distribution block 4pol.	5
X1.1	E06135	connector plug	1
Y5	E05232	mini solenoid valve 3/2-way, M5	1
Z1	E07420	interference suppression filter	1

mark	article number	description	quantity
N35	E07284	oxygen module with O2 sensor	1
N43	B39321	interface board	1
X5.1   X5.2	B32965	potential-free contact H5,H6,H7,C3	2
X6.1   X6.2   X6.3   X6.4	B31202	panel socket for 4-20mA current interface	4
X10.1	E06631	plug-in power supply 230V	1
X10.2	E06763	low-voltage connection cable with socket	1
X10.3	E06429	GSM Box	1
X10.4	E03148	circular connectors with threaded joint	1
X10.5	B39367	potential-free contact C4	1
Y6   Y7	E05232	mini solenoid valve 3/2-way, M5	2

mark	article number	description	quantity
A1.2	E07323	adapter female	1
1	E06821	Y-tube connection port	1
A1.1   A2.1	E07322	adapter male	2
A2.2	E07323	adapter female	1
CO2	E03131	CO2 connection socket	1
filter 1   filter 2	E07324	filter H2O	2
filter air   filter CO2	E03401	filter O2/CO2/N2	2
H2O in	E07050	water connection socket	1

## options

mark	article number	description	quantity
2   3	E06821	Y-tube connection port	2
CO2/2	E03131	CO2 connection socket	1
filter N2	E03401	filter O2/CO2/N2	1
N2	E05505	nipple NW5	1
N2	E05506	straight fitting	1